

WX5025 Datasheet

2024.8

申明





- - 0

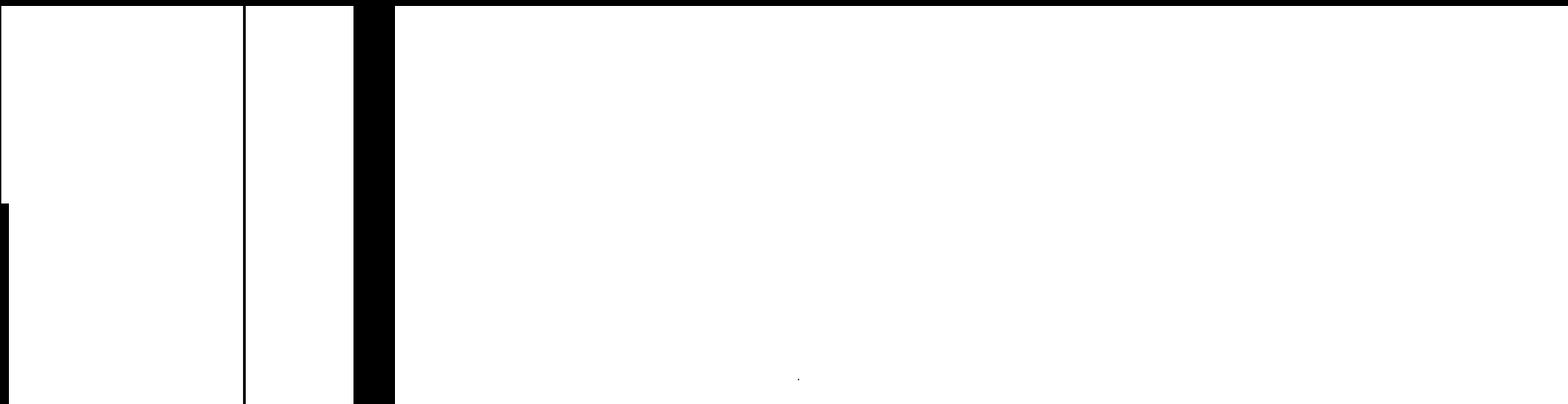
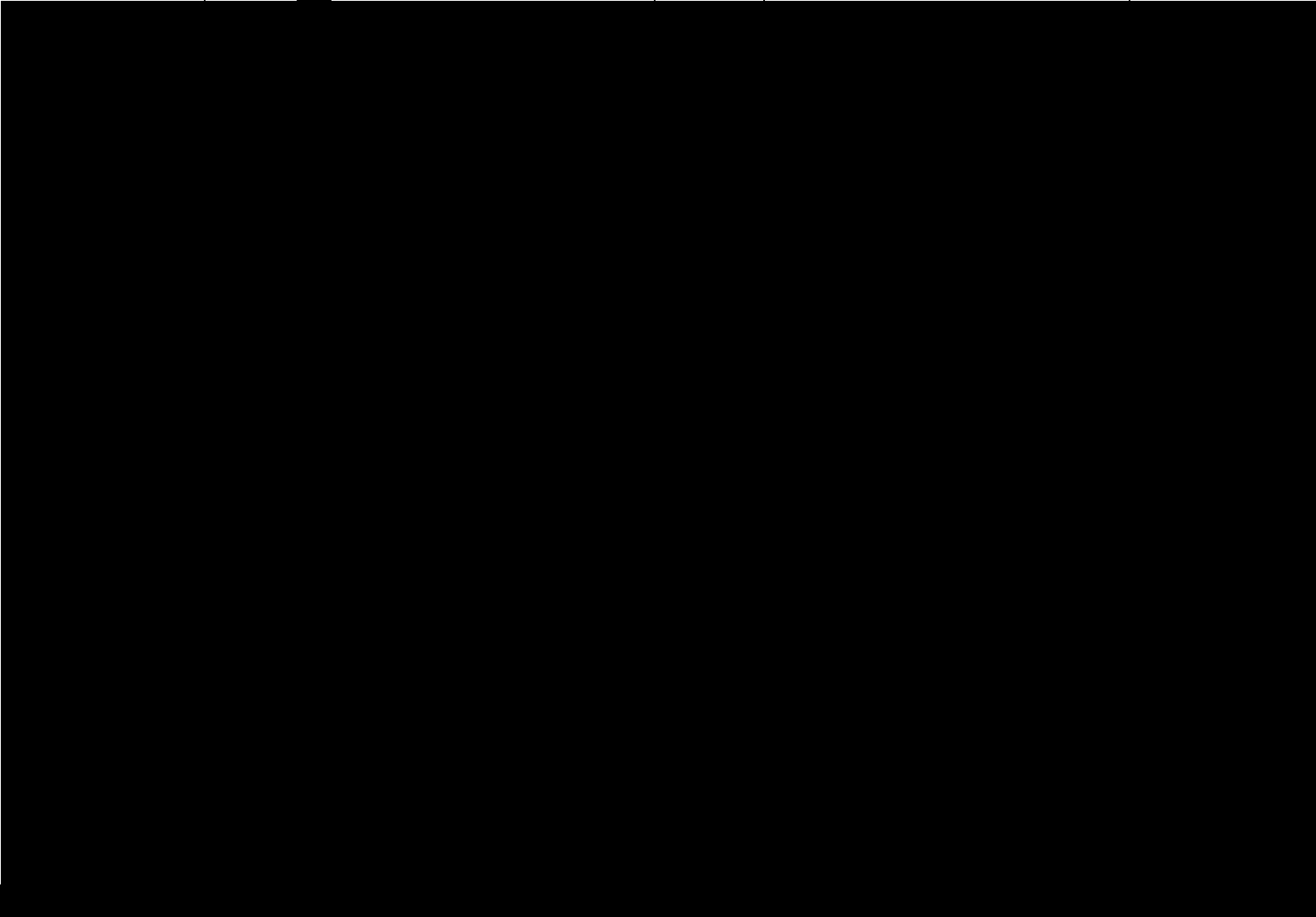

- -

	Min	Typ	Max	Units	Ripple

Typical conditions: room temperature (TA) = 25 C, nominal voltages and continuous network traffic at link speed at full duplex.
 Maximum conditions: maximum operating temperature (TJ) values, Nominal voltage values and continuous network traffic at link speed at full duplex.
 PCIe Configured to x4 Gen8 operation.
 There may be errors in measurement values due to different chip lots, testing environments, and testing methods.

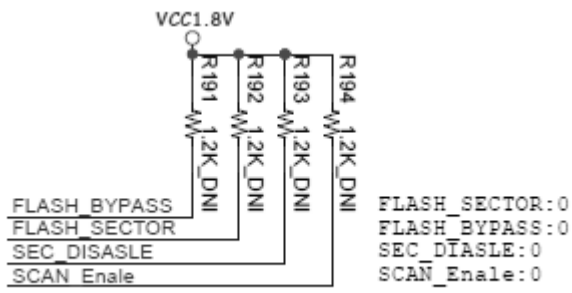
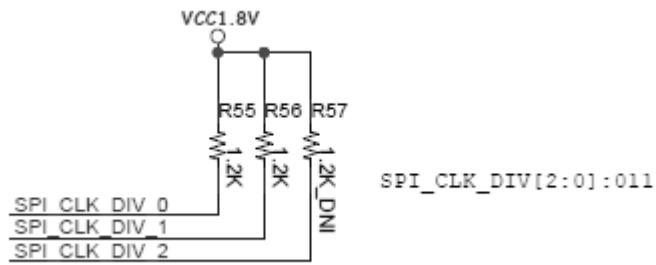

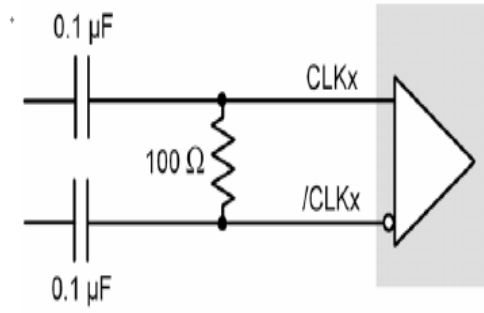

	Min	Typ	Max	Units

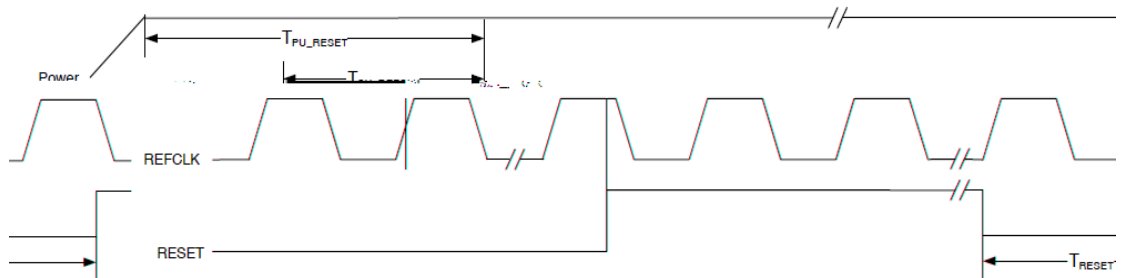

Symbol	Parameter	Min	Typ	Max	Units

Manufacturer	Model type
dh	Q 0 Q
gcli bc	MMN 0Q 0
@ pc	F 0

Manufacturer	Part Number	Model type
I	I	
	E	
I	I	
	I	
O	E P	
	E	

-
-
-
-
-
-
-
-
-

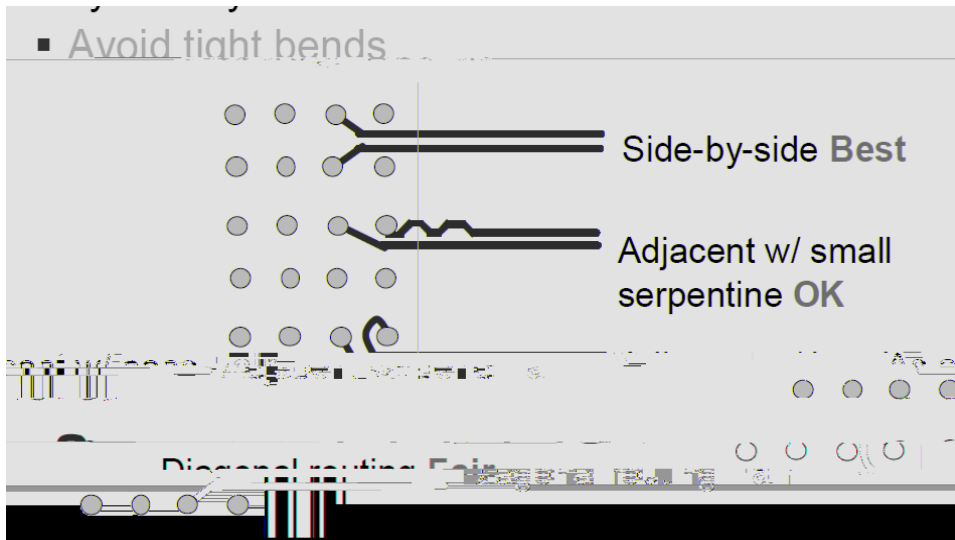

-

•

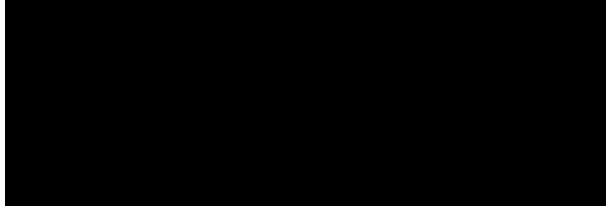

•

•

•

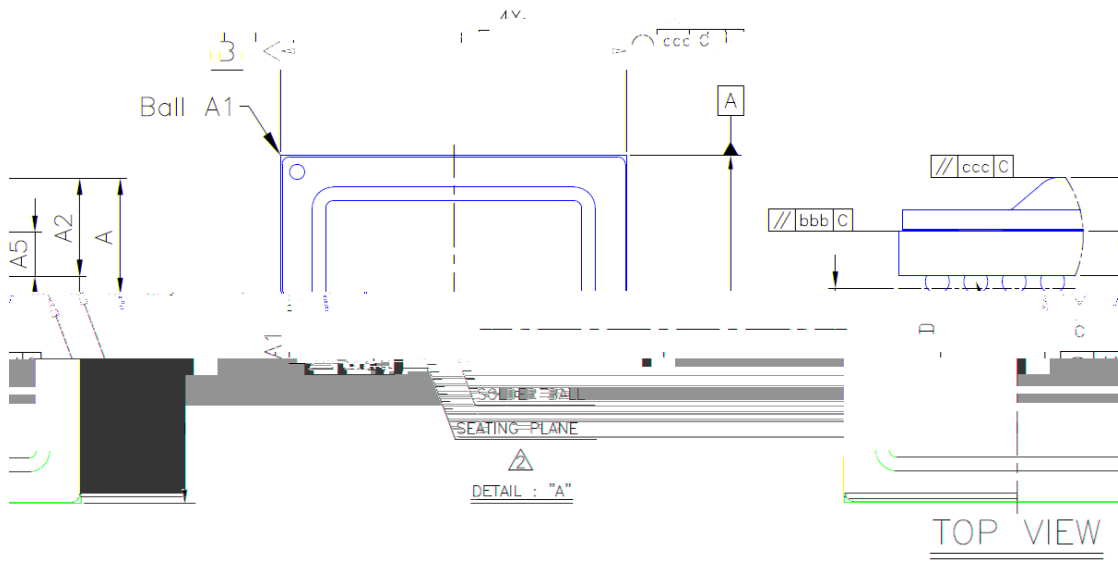
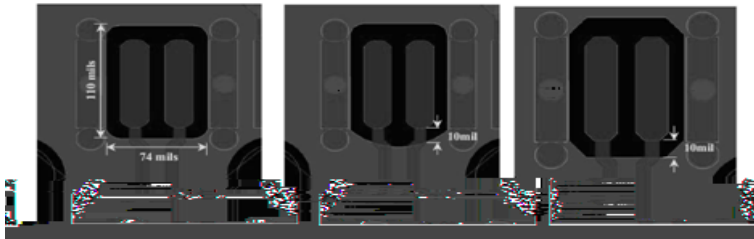

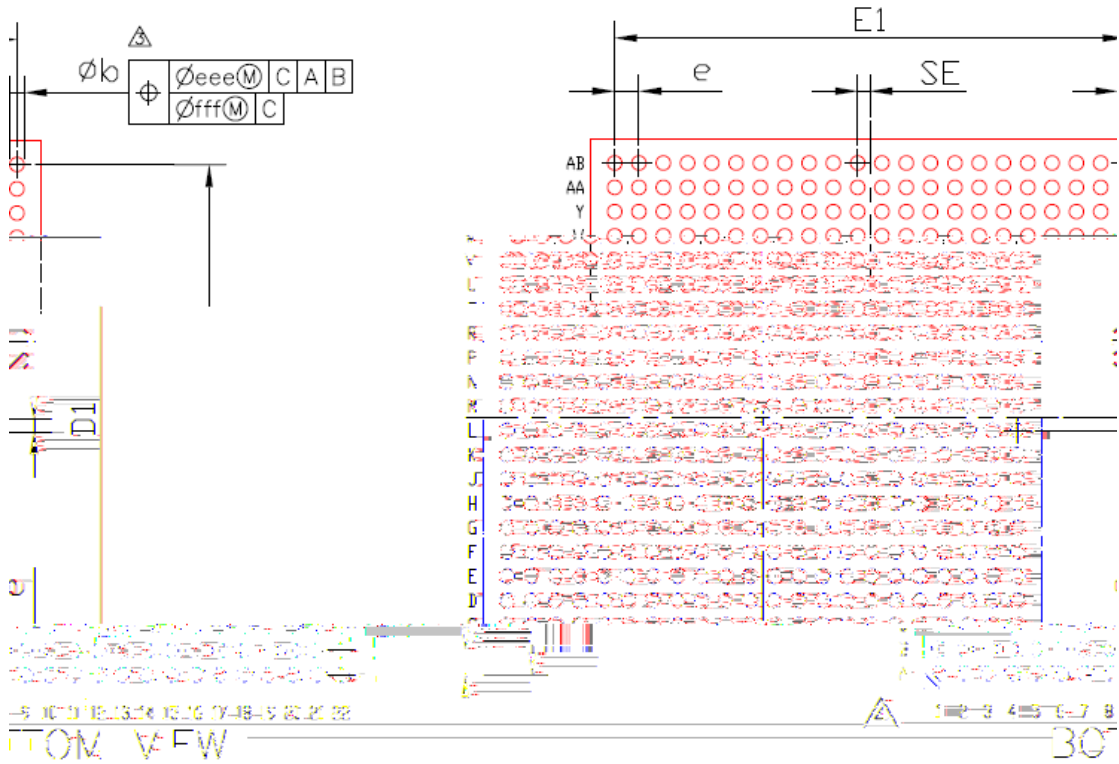
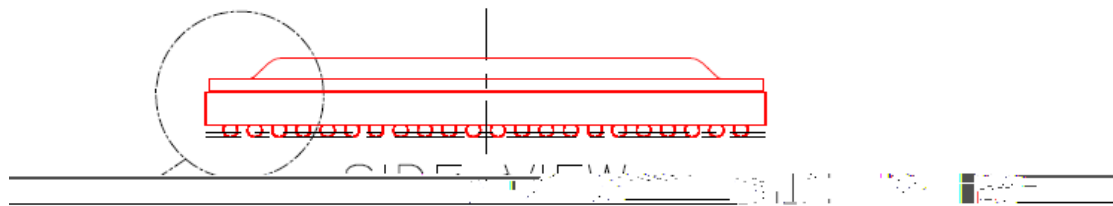

Symbol	Dimension in mm			Dimension in inch		
	MIN	NOM	MAX	MIN	NOM	MAX
A	3.024	3.254	3.484	0.119	0.128	0.137
A1	0.390	0.490	0.590	0.015	0.019	0.023
A2	2.620	2.764	2.908	0.103	0.109	0.114
A5	1.219	1.354	1.489	0.048	0.053	0.059
E	29.000	29.600	30.200	1.142	1.165	1.189

